

A

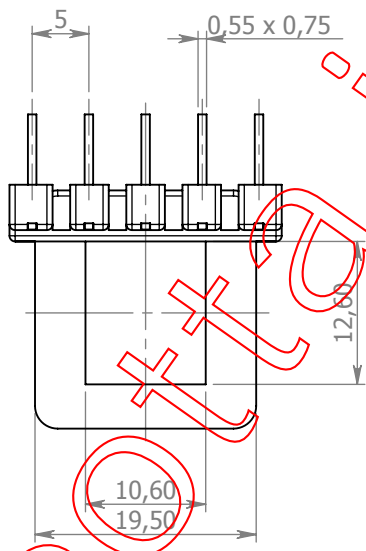

B

C

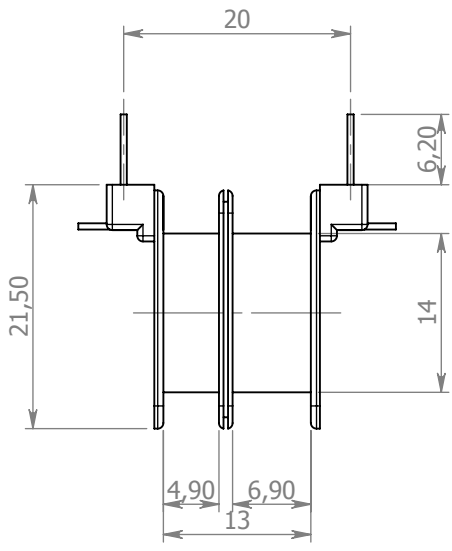
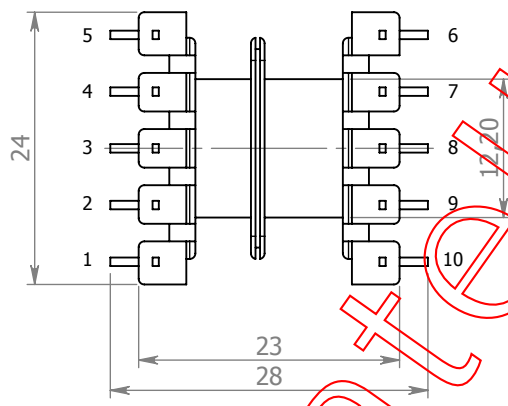

ATTENZIONE: La numerazione dei terminali è riferita al rocchetto con i pins rivolti verso l'alto.

D

E

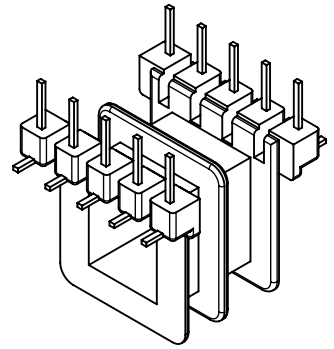

Via IV Novembre, 44
20885
Ronco Briantino -MB-
Tel. 039 6079022
Fax. 039 6079705



MODIFICHE:			
REV.	DATA	APPR.	DESCRIZIONE

NAME	SIGNATURE	DATE		
DIS. Motta A.		20/05/09		
CONTR. Motta A.		20/05/09		
APPR. Motta A.		20/05/09		
MOD.				

CODICE:
CT 60/2

MATERIALE: PA66 G25 V0
MATERIALE PINS: Cu Sn 6

Disegno di proprietà di F.lli MOTTA s.r.l. sono vietati tutti gli utilizzi se non accompagnati da autorizzazione scritta.

DIS. Per lamierino EI30	REV.	A4
PESO:	SCALA: 2:1	