

A

B

C

D

E

F

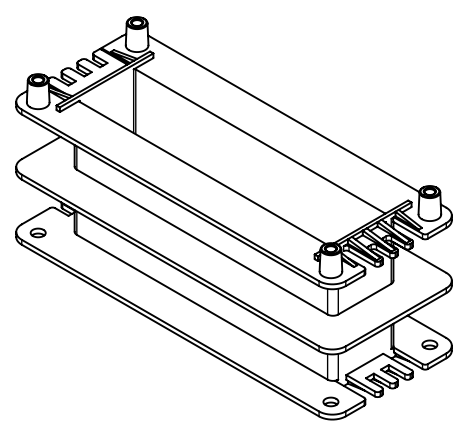
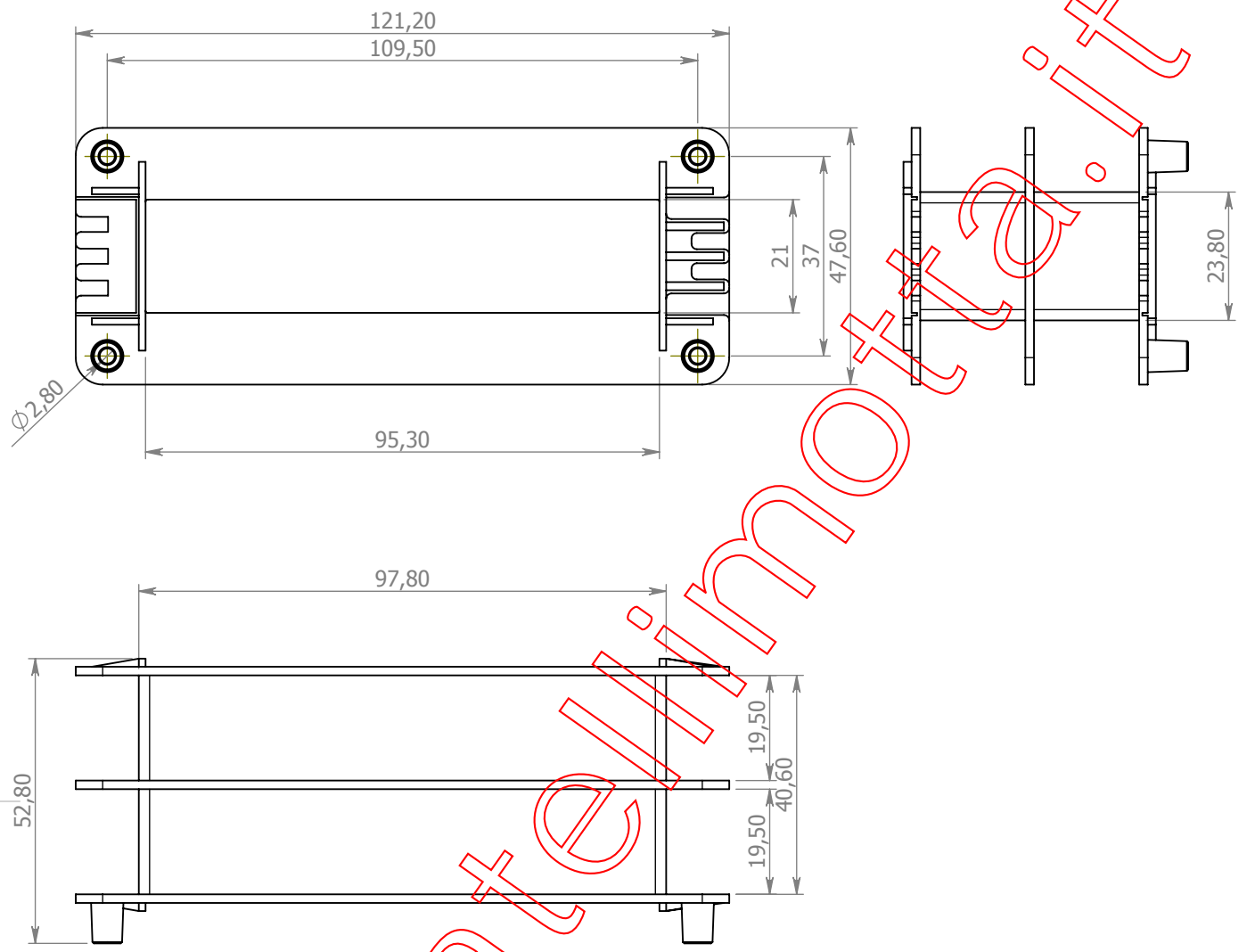

Via IV Novembre, 44
20885
Ronco Briantino -MB-
Tel. 039 6079022
Fax. 039 6079705

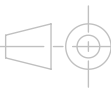

MODIFICHE:			
REV.	DATA	APPR.	DESCRIZIONE

NAME	SIGNATURE	DATE		
DIS.	Motta A.	20/09/14		
CONTR.	Motta A.	20/09/14		
APPR.	Motta A.	20/09/14		
MOD.				

CODICE:
CT 109/1T

MATERIALE: PA66 G25 V0
MATERIALE PINS:
Disegno di proprietà di F.lli MOTTA s.r.l. sono vietati tutti gli utilizzi se non accompagnati da autorizzazione scritta.

DIS.	Per ferrite E70/33/96(3x)	REV.	A4
PESO:		SCALA:	1:1